

**THE NETHERLANDS
(N E D E R L A N D)****COMMUNICATION**Concerning ⁽¹⁾:

- ~~approval granted~~
- approval extended
- ~~approval refused~~
- ~~approval withdrawn~~
- ~~production definitely discontinued~~

of a type of ~~electrical~~/electronic sub-assembly ⁽¹⁾ with regard to Regulation number 10.**Approval number: E4-10R-043138****Extension number: 01**

1. Make (trade name of manufacturer) : SAE CNSAE SAEC
2. Type and general commercial description(s) : SW12258/SW12260
Reversing lamp
3. Means of identification of type, if marked on the ~~vehicle~~/component/
~~separate technical unit~~ ⁽¹⁾ : N/A
- 3.1. Location of that marking : N/A
4. Category of vehicle : N/A
5. Name and address of manufacturer : Foshan Sunway Auto Electrical Co., Ltd.
No.8 South Junye Road, Zone C,
Shishan Scientific & Technological Park,
Nanhai District, Foshan City, Guangdong
Province, 528225, P.R. China
6. In the case of components and separate technical units, location and method of affixing of the approval mark : Moulded on the lens



7. Address(es) of assembly plant(s) : Foshan Sunway Auto Electrical Co., Ltd.
No.8 South Junye Road, Zone C,
Shishan Scientific & Technological Park,
Nanhai District, Foshan City, Guangdong
Province, 528225, P.R. China
8. Additional information (where applicable) : See Appendix
9. Technical service responsible for carrying out the tests : TÜV SÜD Auto Service GmbH
Westendstraße 199
D-80686 München
10. Date of test report : 2015-05-08
11. Number of test report : 14-01071-CX-SHA-01
12. Remarks (if any) : See Appendix
13. Place : Zoetermeer
14. Date : 02-JUN-2015
15. Signature :



16. The index to the information package lodged with the approval authority, which may be obtained on request, is attached.
17. Reasons for extension : Add statement of differences description

⁽¹⁾ Strike out what does not apply.

APPENDIX

to type-approval communication form number: **E4-10R-043138**, Extension number: **01**

concerning the type-approval of an ~~electrical~~/electronic sub-assembly⁽¹⁾ under Regulation number 10.

1. Additional information
 - 1.1. Electrical system rated voltage : 12 V DC ~~pos./neg.~~ ground⁽¹⁾
 - 1.2. This ESA can be used on any vehicle type with the following restrictions : No restrictions
 - 1.2.1. Installation conditions, if any : Attached the mounting base to Vehicle
 - 1.3. This ESA can be used only on the following vehicle types : N/A
 - 1.3.1. Installation conditions, if any : N/A
 - 1.4. The specific test method(s) used and the frequency ranges covered to determine immunity were : N/A
 - 1.5. Laboratory accredited to ISO 17025 and recognized by the Approval Authority responsible for carrying out the tests : N/A
2. Remarks : N/A

⁽¹⁾ Strike out what does not apply.

Technical Report No.: 14-01071-CX-SHA-01
Manufacturer: Foshan Sunway Auto Electrical Co., Ltd.
Type: SW12258/SW12260

Page 1 of 4

TECHNICAL REPORT

No.: 14-01071-CX-SHA-01

Test of a type of a component

according to the Regulation of the Economic Commission for Europe relating to

Electromagnetic Compatibility

No.: ECE R10

Including all amendments up to

04 Supplement 02

Approval status	
<input type="checkbox"/>	Granting of a type approval
<input checked="" type="checkbox"/>	Extension/correction to type approval no.: E4-10R-043138-00

Technical Report No.: 14-01071-CX-SHA-01
Manufacturer: Foshan Sunway Auto Electrical Co., Ltd.
Type: SW12258/SW12260

Page 2 of 4

1. General

- 1.1. Make : SAE CNSAE SAEC
- 1.2. Type : SW12258/SW12260
- 1.3. Variants : N/A
- 1.4. Commercial description(s) : Reversing lamp
- 1.5. Category of vehicle : N/A
- 1.6. Name and address of manufacturer : Foshan Sunway Auto Electrical Co., Ltd.
No.8 South Junye Road, Zone C,
Shishan Scientific & Technological Park,
Nanhai District, Foshan City, Guangdong
Province, 528225, P.R. China
- 1.7. Name and address of representative : N/A
- 1.8. Information document
- No. : SW12258/SW12260-01
- Date of issue : 2014-12-16 (YYYY-MM-DD)
- Last date of amendment : 2015-05-04 (YYYY-MM-DD)
- 1.9. Technical description of the component : See manufacturer's information document

2. Test record : N/A

Technical Report No.: 14-01071-CX-SHA-01
 Manufacturer: Foshan Sunway Auto Electrical Co., Ltd.
 Type: SW12258/SW12260

3. Enclosure(s)

- Annex 1 List of modification
- Annex 2 Test record
- Annex 2a Measurement diagrams of the radio interference 30 MHz – 1 GHz
- Annex 2b Conducted transients from ESAs to the vehicle power supply
- Annex 2c Immunity of ESA to conducted transient interferences
- Annex 2d Immunity of ESAs to electromagnetic radiation
- Annex 3 Information document

4. Statement of conformity

The information folder as mentioned under No. 1.8. and the type described therein are in compliance with the test specification mentioned above. The worst-case was selected in accordance with document “Preparation of Test Reports”.

The test report may be reproduced and published in full and by the client only. It can be reproduced partially with the written permission of the test laboratory only.

München, 2015-05-08
 (YYYY-MM-DD)



Gu, Qing
 Test Laboratory / DIN EN ISO 17025

Approval authority	Country	Registration-number	Actual scope list
Kraftfahrt-Bundesamt (KBA)	Germany	KBA-P 00100-10	http://www.kba.de
Vehicle Certification Agency (VCA)	United Kingdom	VCA-TS-006	http://ec.europa.eu/enterprise/sectors/automotive/approval-authorities-technical-services/technical-services/index_en.htm
Approval Authority of the Netherlands (RDW)	The Netherlands	RDWT-082-01	
National Standards Authority of Ireland (NSAI)	Ireland	Technical Service Number: 49	
Vehicle Safety Certification Center (VSCC)	Taiwan	DE04-06-2	http://www.vsc.org.tw/English/Default.aspx

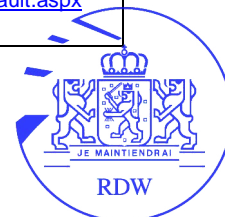

Technical Report No.: 14-01071-CX-SHA-01
Manufacturer: Foshan Sunway Auto Electrical Co., Ltd.
Type: SW12258/SW12260

Annex 1

List of modification

Correction of : N/A

Modification of : N/A

Addition of : Add statement of differences description
(The extension only adding statement, therefore no additional test should be performed.)

Deletion of : N/A

Content – ECE R10

DOCUMENT	PAGE
Technical Description	2
Appearance Drawing	3
Assembly Drawing	4
Circuit Diagram	5
PCB Circuit Diagram	6
PCB Layout	7
Bill of Materials	8-9
Statement	10
Approval History	11
Application for Approval	11

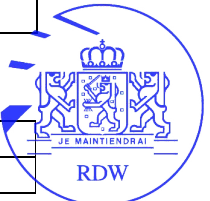

INFORMATION DOCUMENT FOR TYPE-APPROVAL OF AN ELECTRIC/ELECTRONIC
SUB-ASSEMBLY WITH RESPECT TO ELECTROMAGNETIC COMPATIBILITY
ACCORDING ANNEX IIB OF ECE-R10.04

- 1 Make (trade name of the manufacturer) : SAE CNSAE SAEC
- 2 Type and general commercial description(s) : SW12258/SW12260
- commercial description(s) : Reversing lamp
- version(s) :
- 3 Means of identification of type, if marked on the component/separate technical unit : N/A
- 3.1 Location of that marking : N/A
- 4 Name and address of the manufacturer : Foshan Sunway Auto Electrical Co., Ltd.
No.8 South Junye Road, Zone C, Shishan Scientific & Technological Park, Nanhai District, Foshan City, Guangdong Province, 528225, P.R. China
- 4.1 Name and address of authorized representative, if any : N/A
- 5 In the case of components and separate technical units, location and method of affixing of the approval mark : Moulded on the lens
- 6 Address(es) of assembly plant(s) : Foshan Sunway Auto Electrical Co., Ltd.
No.8 South Junye Road, Zone C, Shishan Scientific & Technological Park, Nanhai District, Foshan City, Guangdong Province, 528225, P.R. China
- 7 This ESA shall be approved as a : Component/STU
- 8 Any restrictions of use and conditions for fitting : No restrictions

Type	SW12258/SW12260
Page	2 of 11



Appearance Drawing



Type	SW12258/SW12260
Page	3 of 11



Assembly Drawing

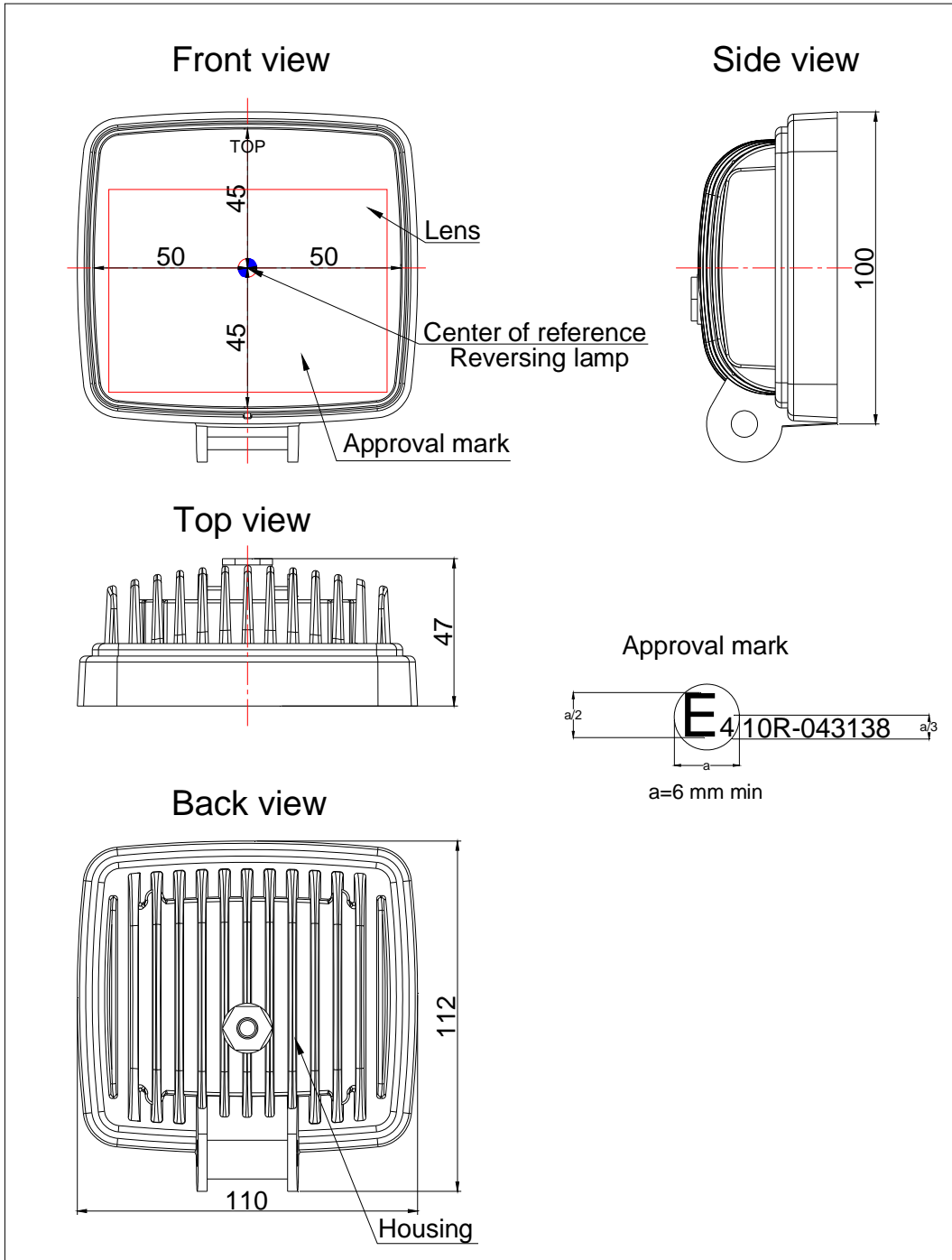

Type	SW12258/SW12260
Page	4 of 11



Circuit Diagram

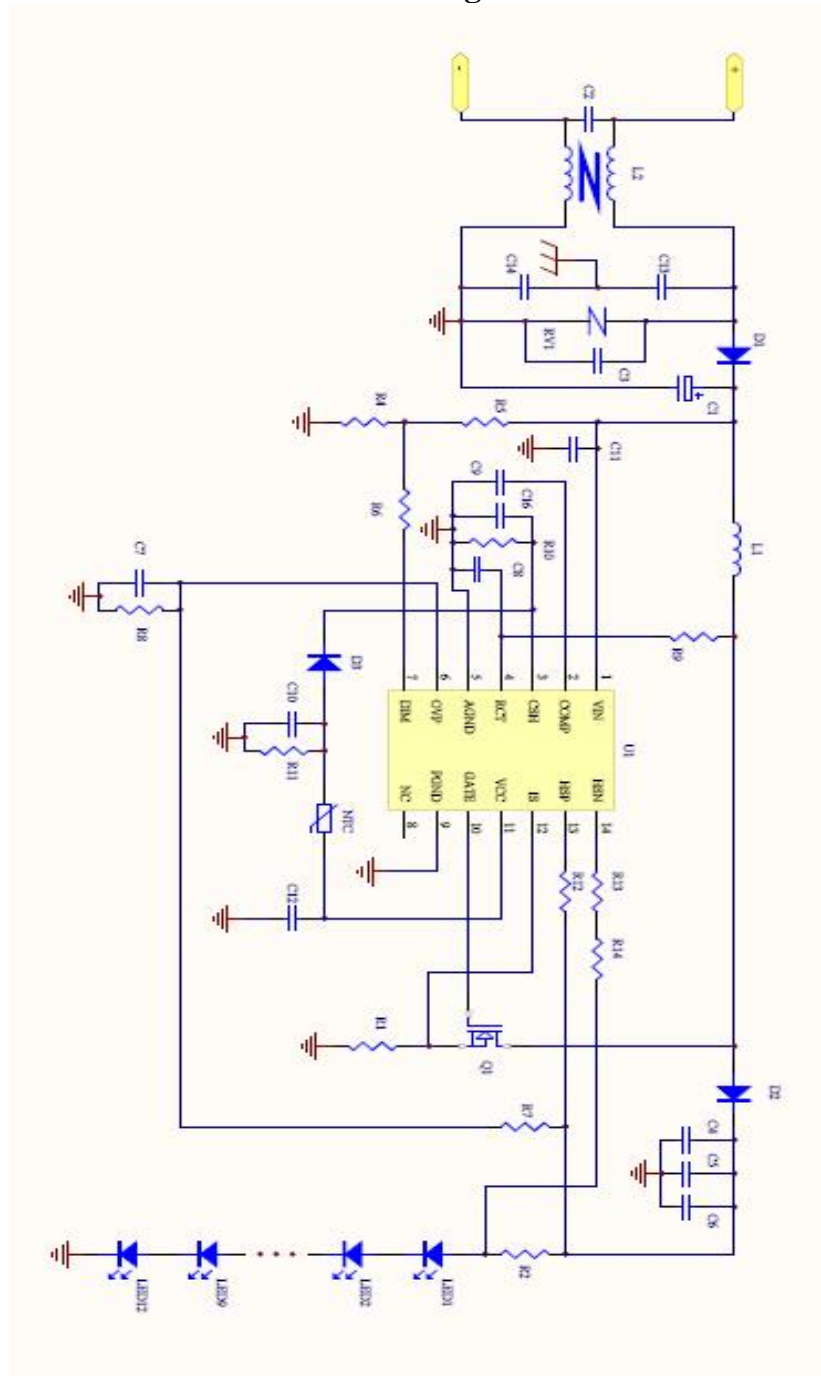

PCB Circuit Diagram

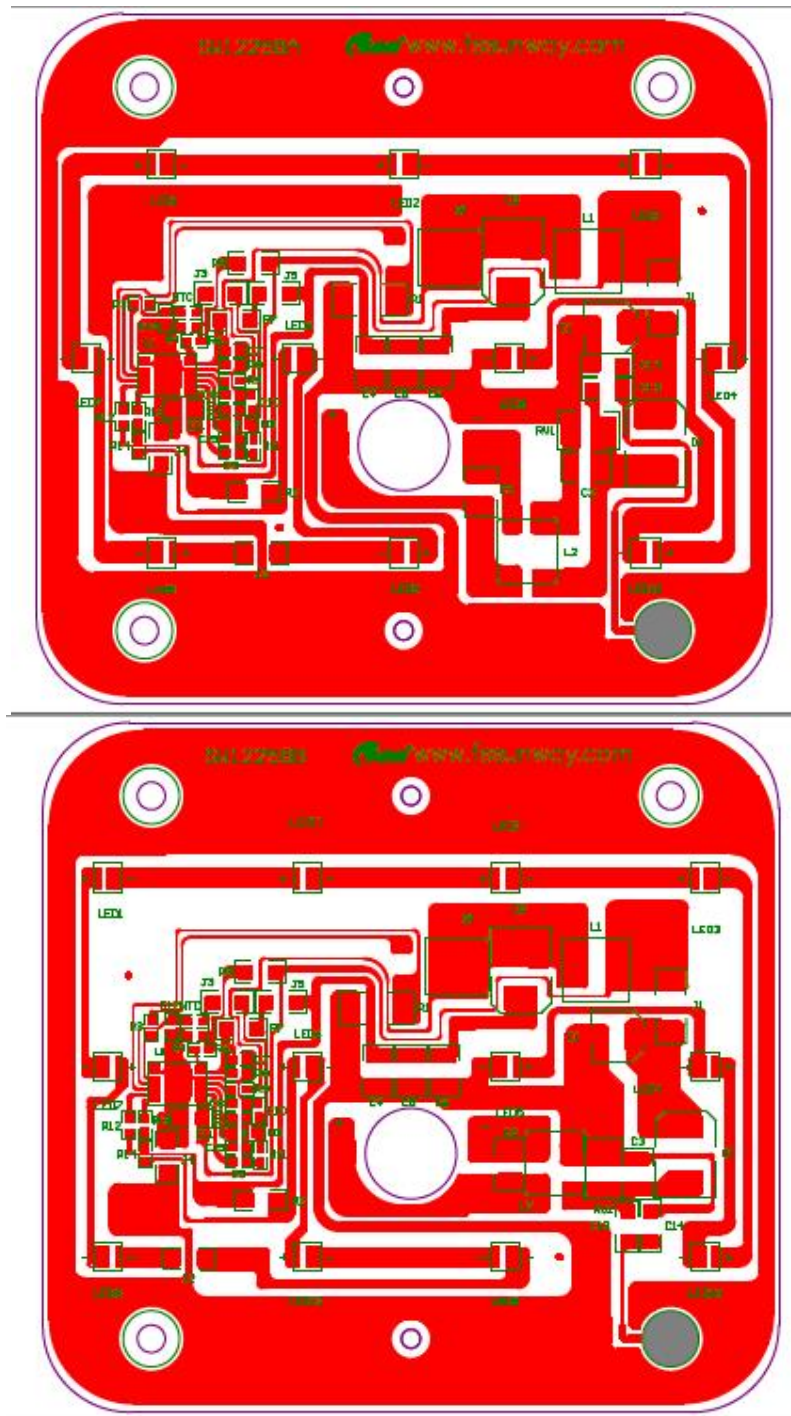

Type	SW12258/SW12260
Page	6 of 11

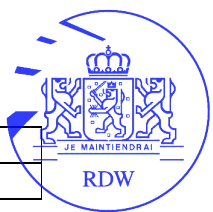

PCB Layout

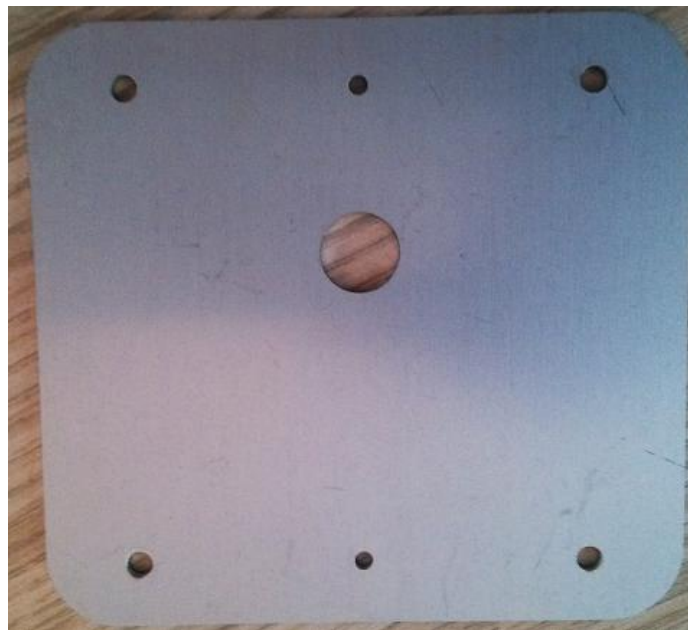
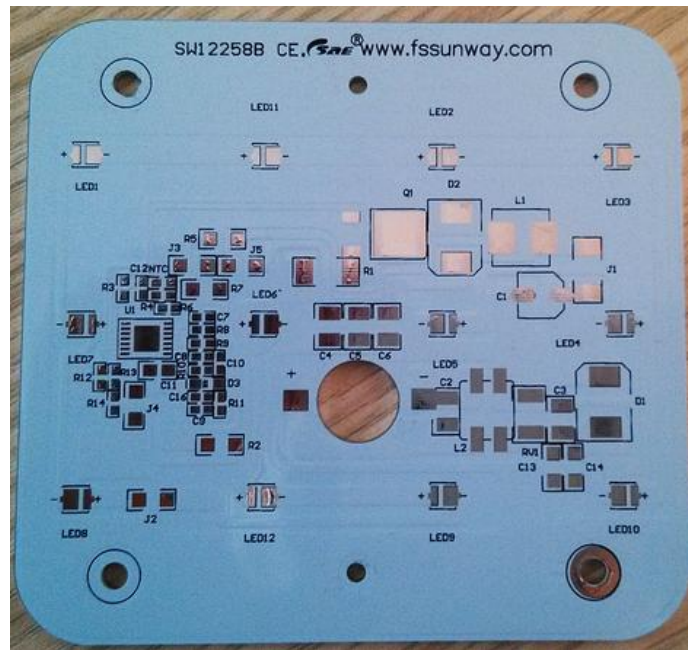

Type	SW12258/SW12260
Page	7 of 11



Bill of Materials (1)

Comment	Designator	Footprint	Quantity
Schottky diode	D1	SS56 SMC	1
Schottky diode	D2	SS310 SMC	1
Switching diode	D3	1N4148 SOD-123	1
integrated circuit	U1	LM3429Q1MH TSSOP-14	1
field-effect tube	Q1	AOD482 TO-252	1
Power chip inductor	L1	22uH± 20% integrated inductance 6.8mm × 6.8mm × 5mm (BWSL0603-220M)	1
common mode choke	L2	T6 × 3 × 3 vertical type 120uH 20% wire diameter :0.4mm × 4Ts	1
thermistor NTC	NTC	680K Ω 5% (room temperature25°C) 0603	1
chip resistor	R11	73.2K Ω 1% 0603	1
chip resistor	R1	0.040 Ω 1% 2512	1
chip resistor	R2	1.2 Ω 1% 1206	1
chip resistor	R4,R8	10K Ω 1% 0603	2
chip resistor	R9	35.7K Ω 1% 0603	1
chip resistor	R7	510K Ω 1% 1206	1
chip resistor	R5	35.7K Ω 1% 1206	1
chip resistor	R12,R13,R6	1K Ω 1% 0603	3
chip resistor	R3,R14	10 Ω 1% 0603	2
chip resistor	J5	100K Ω 1% 1206	1
chip resistor	R10	12.4K Ω 1% 0603	1
chip resistor	J1	0 Ω 1% 2512	1

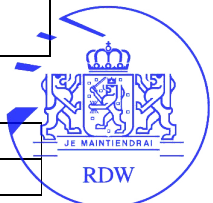





Bill of Materials (2)

Comment	Designator	Footprint	Quantity
chip resistor	J2-J4	0Ω 1% 1206	3
chip resistor	C4-C6	2.2UF/100V 10% 1210	3
chip resistor	C7	100P/50V NOP 10% 0603	1
chip resistor	C15	47P/50V NOP 10% 0603	1
chip resistor	C8	102/50V NOP 10% 0603	1
chip resistor	C9	104/25V X7R 10% 0603	1
chip ceramic capacitor	C12	6.8uF/16V (-40°C~125°C) 0603	1
chip ceramic capacitor	C10	103/16V (-40°C~125°C) 0603	1
chip resistor	C2-C3	10uF/50V 10% 1210	2
chip resistor	C11	4.7uF/50V 10% 0805	1
SMD aluminum electrolytic capacitor	C1	22uF/50V Φ6.3mm×5.3mm	1
Circuit board	/	SW12258A aluminum substrate 85×80mm × 1.5mm white oil	1
LED	LED1-LED10	OSRAM 1.5W (GW PSLPS1.EC-KTLP-5C7E)	10
piezoresistor	RV1	56V 1812	1
chip capacitor	C13, C14	103/200V 1206	2
lens	/	PMMA	1
housing	/	ADC12	1



Statement

We, Foshan Sunway Auto Electrical Co., Ltd. have products of type SW12258 SW12258B and SW12260, they have different shapes of PCB, but they have the same of circuit diagram and bill of materials, as follows:

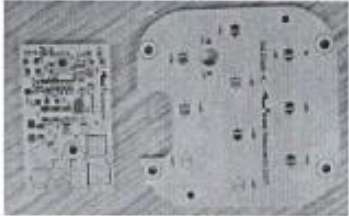
No.	Version	Differences description	
		Photo	PCB
1	SW12258		
2	SW12258B		
2	SW12260		

Foshan Sunway Auto Electrical Co., Ltd.

Signature: 

Stamp: 

Date: 2015.05.02



Foshan Sunway Auto Electrical Co., Ltd. SW12258/SW12260-01
First extended date: May 04, 2015

Approval history

Extension No.	Reason for extension	Application date	
		First application date	
00 (Base approval)	Not applicable	December 16, 2014	
01	Add statement of differences description	First extended date	May 04, 2015
--	--	--	--

Application for approval

Subject	:	Reversing lamp
Manufacturer	:	Foshan Sunway Auto Electrical Co., Ltd.
Component type	:	SW12258/SW12260
Applicable EC Directive	:	ECE R10.04
Existing approval number	:	E4-10R-043138
Reason for extension 01	:	Add. statement of differences description
Date	:	May 04, 2015

Type	SW12258/SW12260
Page	11 of 11

